

WARNING!

Toll fraud is committed when individuals unlawfully gain access to customer telecommunication systems. This is a criminal offense. Currently, we do not know of any telecommunications system that is immune to this type of criminal activity. AltiGen Communications, Inc., will not accept liability for any damages, including long distance charges, which result from unauthorized and/or unlawful use. Although AltiGen Communications, Inc., has designed security features into its products, it is your sole responsibility to use the security features and to establish security practices within your company, including training, security awareness, and call auditing.

NOTICE

While every effort has been made to ensure accuracy, AltiGen Communications, Inc., will not be liable for technical or editorial errors or omissions contained within the documentation. The information contained in this documentation is subject to change without notice.

This documentation may be used only in accordance with the terms of the AltiGen Communications, Inc., License Agreement.

AltiGen Communications, Inc.
4555 Cushing Pkwy.
Fremont, CA 94538
Telephone: 510-252-9712
Fax: 510-252-9738
E-mail: info@altigen.com
Web site: www.altigen.com

TRADEMARKS

AltiGen, AltiServ, AltiWare, AltiSpan, AltiReach, AltiLink, AltiConsole, AltiAdmin, IP 710, Zoomerang, IPTalk, AltiReport, and SuperQ are trademarks or registered trademarks of AltiGen Communications, Inc.

All other brand names mentioned are trademarks or registered trademarks of their respective manufacturers.

Copyright © AltiGen Communications, Inc., 2005. All rights reserved.
Printed in U.S.A. 08/2005 4290-0012-5.0A

Contents

- Contents i**
- Warranty v**
- Preface: About This Manual vii**

CHAPTER 1

- An Overview of the IP 710 1**
 - Hardware Components 5

CHAPTER 2

- System & Network Requirements 7**
 - System Requirements 7
 - Network Requirements 7
 - AltiAdmin/ACM Admin Configuration Requirements 7
 - AltiGen IP Phone Service 8
 - Plug and Play Feature 8
 - Basic Mode 8
 - Normal Operation 8

CHAPTER 3

- Installation 9**
 - Local Installation 9
 - Remote Installation 17
 - Verifying the Phone Startup Process 19
 - Resolving Errors Upon Startup. 19
 - Other Phone Already Logged On To Extension 20
 - Executing Plug and Play After IP Phone is Started 20
 - Restoring Default Settings 20
 - Rebooting the IP 710 Phone 21
 - To Use IP 710 in Power over Ethernet Mode 21
 - To Remove the PoE Module. 22

Operation Notes	22
-----------------------	----

CHAPTER 4

Phone Configuration	23
Phone Settings	23
System Settings	24
Network Settings	25
Registration	26
Enabling/Disabling DHCP	26
Configuring IP Settings	26
Assigning a Local IP Address	27
Assigning a TFTP Server	27
Updating Phone Firmware	27
Resolving Errors Upon Rebooting	29
Configuring NAT	29
Enabling NAT	29
Setting Ring Tones	30
Distinctive Ringing Support	30
Workgroup Status Display	31
Greeting Button	31
Activity Button	31

CHAPTER 5

Phone Functions	33
Supported Telephony Features	34
Glossary	41
Appendix A	47
Specifications	47
Firewall Considerations	48
Troubleshooting	49
LCD Messages	52
Normal Operating Mode Messages	52
Local Menu Configuration Messages	53
IP Phone Running Messages	54

IP Phone Boot Messages	55
User Reference	56
Index	63

Warranty

What The Warranty Covers

AltiGen Communications warrants its hardware products to be free from defects in material and workmanship during the warranty period. If a product proves to be defective in material or workmanship during the warranty period, AltiGen Communications will, at its sole option, repair, refund or replace the product with a like product.

How Long the Warranty Is Effective

All AltiGen Communications products are warranted for one (1) year for all parts from the date of the first end user purchase.

Whom the Warranty Protects

This warranty is valid only for the first end user purchaser.

What the Warranty Does Not Cover

1. Any product on which the serial number has been defaced, modified or removed.
2. Damage, deterioration or malfunction resulting from:
 - a) Accident, misuse, neglect, fire, water, lightning, or other acts of nature, unauthorized product modification, or failure to follow instructions supplied with the product.
 - b) Repair or attempted repair by anyone not authorized by AltiGen Communications.
 - c) Any damage of the product due to shipment.
 - d) Removal or installation of the product.
 - e) Causes external to the product, such as electric power fluctuations or failure.
 - f) Use of supplies or parts not meeting AltiGen Communications' specifications.
 - g) Normal wear and tear.
 - h) Any other cause which does not relate to a product defect.
3. Shipping, installation, set-up and removal service charges.

How to Obtain Service

End user customers should contact your Authorized AltiGen Dealer for service.

Authorized AltiGen Dealers must follow the steps below for service:

1. Take or ship the product (shipment prepaid) to your AltiGen distributor or to AltiGen Communications, Inc.

All materials being returned to AltiGen must have an associated RMA number. RMA numbers are issued by AltiGen Customer Service and can be obtained by calling 1-888-ALTIGEN (258-4436) or submit an online RMA request via the AltiGen Partner Resource Center, at <http://dealer.altigen.com>. AltiGen reserves the right to refuse return of any material that does not have an RMA number. The RMA number should be clearly marked on the outside of the box in which the material is being returned. For example:

Attn.: RMA # 123
AltiGen Communications, Inc.
4555 Cushing Pkwy.
Fremont, CA 94538

Upon authorization of return, AltiGen will decide whether the malfunctioning product will be repaired or replaced.

2. To obtain warranty service, you will be required to provide:
 - a) The date and proof of purchase
 - b) Serial number of the product
 - c) Your name and company name
 - d) Your shipping address
 - e) A description of the problem.
3. For additional information contact your AltiGen Dealer or AltiGen Communications, Inc.

Effect of State Law

This warranty gives you specific legal rights, and you may also have other rights which vary from state to state. Some states do not allow limitations on implied warranties and/or do not allow the exclusion of incidental or consequential damages, so the above limitations and exclusions may not apply to you.

Sales Outside the U.S.A.

For AltiGen Communications products sold outside of the U.S.A., contact your AltiGen Communications dealer for warranty information and services.

Preface: About This Manual

This document describes how to get the Alti-IP 710 phone up and running on a Voice over IP (VoIP) network. For complete and detailed information on procedures that you need to perform on AltiGen's AltiWare application or other network devices, refer to the *AltiWare OE System Installation and Administration Manual* or *AltiContact Manager System Administration Manual*.

Another document, the *IP 710 Quick Reference Card*, covers basic end user phone features, configuration from the IP phone, and AltiServ feature codes.

This guide contains the following chapters and appendices:

Chapter 1, An Overview of the IP 710, provides an overview and description of the IP 710.

Chapter 2, System and Network Requirements describes configuration requirements.

Chapter 3, Installation, describes how to properly install the IP 710, how to configure network settings, and operation notes.

Chapter 4, Configuration, describes how to configure phone settings for the IP 710.

Chapter 5, Phone Functions, provides an overview of the IP 710 basic functions.

Appendix A, provides phone specifications, tips for troubleshooting the IP 710, LCD message information and user reference information.

Glossary

Overview

The *IP 710 Administration Manual* provides information about how to set up, connect cables to, and configure an IP 710 phone. It also provides information on how to configure the network and IP settings, and how to change the settings and options of the IP 710 phone.

Related Documentation

- *IP 710 Quick Reference Card*
- *AltiWare OE/ACC System Installation and Administration Manual or AltiContact Manager System Administration Manual*

An Overview of the IP 710

The IP 710 class of AltiGen IP phones is an H.323-compliant, business telephone that provides voice communication over an IP network.

The IP 710 provides functionality similar to traditional analog phones, including automatic redial, on-hook dialing, hands-free operation, 15 programmable keys, LCD display and headset port support.

The main components of the phone are illustrated in the figures below and described in the table that follows each figure.



Figure 1. IP 710 Phone

1	LCD Screen	Displays features such as time, phone number, caller ID, call waiting, line/call status and call time.
---	------------	--

2	Message Waiting Indicator Light*	Blinks when a message is waiting or a call is coming in.
3	Soft Keys* 1-15	15 soft keys can be configured by the system administrator in AltAdmin/ACM Admin as a Busy Lamp Field (BLF) key, an Altiserv Feature Code key, a Speed Dial key, a Line Park key, a Call Record key, a Workgroup Status key, or a Phone Setting key.
4	Greeting*	Greeting access button.
5	Activity*	Activity code access button.
6	VoiceMail*	Voice mail access button.
7	Intercom*	Incoming voice path through speaker, indicated by the button's blinking light.
8	Headset	Hook switch for headset device.
9	Conference*	Initiates a conference call, indicated by the button's blinking light.
10	Hold*	Places a call on hold, indicated by the button's blinking light.
11	Mute	Engages or disengages mute function.
12	Speaker	Enables speaker.
13	Menu	Displays the phone's menu.
14	Navigation buttons	<p>▲ / ▼ buttons let you scroll through text on the LCD screen.</p> <p>▶ button selects a menu item or setting.</p> <p>◀ button returns to previous configuration menu or deletes the last digit input.</p>
15	Enter	Confirms selections made in the LCD, including settings.

16	Release	Releases a call, exits from the menu, releases phone from an active state.
17	Redial*	Redials up to last 16 calls and up to 32 digits.
18	SpeedDial*	Displays a list of Station Speed Dial entries configured through Altiview/AltiAgent or AltAdmin/ACM Admin. To make an outgoing call, use the ▲/▼ buttons to select a Speed Dial entry, then press Enter .
19	Call Log*	Displays the caller IDs of up to 99 incoming calls. To dial, use the ▲/▼ buttons to select a call log entry, then press Enter .
20	Flash*	For system feature codes that need a flash to complete.
21	Transfer*	Transfers a call.
22	Volume	Adjusts volume of ringer, speaker, handset and headset.
23	Dial Pad	Functions like a dial pad on a traditional telephone and is also used for inputting some settings that are accessed through the phone's menu.

Note: * Indicates a normal operating mode key feature, which is available only after registering the IP 710 with the phone server and logged in as an extension.

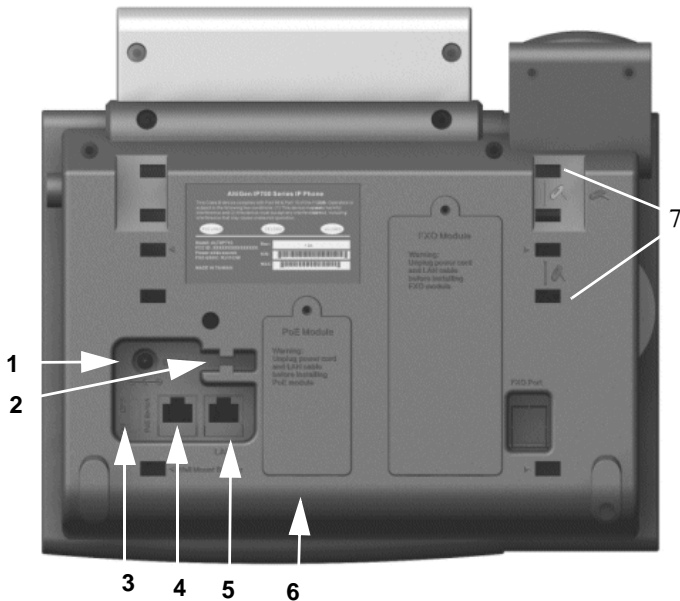

Figure 2. IP 710 Phone, Bottom View

1	DC Port	Connects to power outlet
2	Power Cable Restraint	Secures the power cable, preventing it from accidentally being pulled out
3	DC/PoE Switch	Switches between DC power and Power over Ethernet
4	PC Access Port	Connects to PC (10/100 Base T)
5	LAN Port	Connects to network (10/100 Base T)
6	PoE Module Cover	Covers the optional Power over Ethernet Module
7	Slots for the Phone Stand	Four slots on each side for inserting the phone stand to set the phone at the desired angle

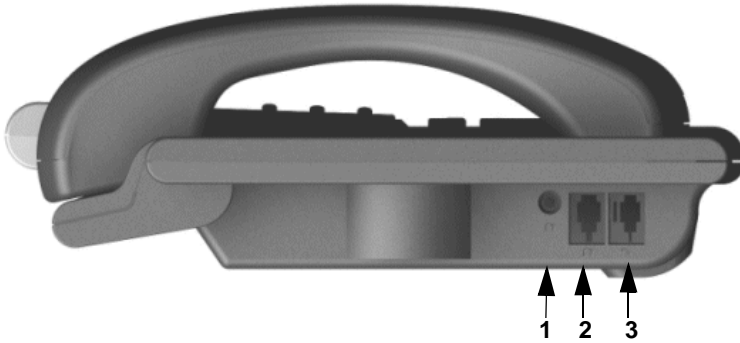

Figure 3. IP 710 Phone, Left View

1	Headset 2.5mm plug receptacle	Connects to a 2.5mm headset
2	Headset RJ port	Connects to a non-amplified headset with RJ9 connector
3	Handset port	Connects to a handset

Hardware Components

The following hardware items are included in this package:

- IP 710 set and stand
- Handset
- Handset cord
- AC adapter (Input: 100-240V; Output: DC 5V, 2A)
- Power cord
- Network cable

Optional items can be purchased separately:

- Power over Ethernet (PoE) module
- Wall mount bracket

System & Network Requirements

System Requirements

- AltiWare OE 5.0A Update 3 or higher

Note: A lower version of AltiWare may cause the IP phone to lose several advanced features, resulting in use as a basic H.323 phone.

- AltiGen OE 5.0A GateKeeper or higher (to support plug and play functionality)

Network Requirements

- Network connection — the IP phone must have TCP/IP connection to the related AltiWare system

Important: Make sure an Ethernet switch is used, rather than a hub, in the corporate LAN. An Ethernet switch with QoS support is preferred.

- DHCP Server (to get an IP address dynamically, when necessary)
- TFTP Server (to update the IP phone firmware, when necessary)
- GateKeeper (for plug and play feature)

AltiAdmin/ACM Admin Configuration Requirements

- The IP 710 requires an IP extension to be enabled in AltiAdmin to handle call processing. Refer to the “Setting Up IP Extensions” chapter in the *AltiWare OE/ACC System Installation & Administration Manual* or *ACM System Administration Manual* for detailed instructions on how to set up an IP extension to manage the IP phone.
- The IP phone settings must be pre-configured in AltiAdmin/ACM Admin before setting up configuration for the IP 710.

AltiGen IP Phone Service

AltiGen IP Phone Service is installed together with AltiWare and connects to AltiWare through enhanced AltiLink+ protocol on behalf of IP 710 phones. This service must be running for the IP 710 to operate. If IP Phone Service stops while the IP 710 is on a call, the call will be disconnected.

Plug and Play Feature

The IP 710 supports a plug and play feature when running AltiWare. When the phone is first booted up, this feature enables the phone to automatically discover the AltiServ IP address, instead of having to program the phone manually. Refer to step 7 on page 16 for requirements and setup.

Note: The plug and play feature requires AltiGateKeeper Discovery and a single gatekeeper on the LAN.

Basic Mode

The IP 710 operates in Basic mode if it fails to register with AltiWare during the startup mode. When in Basic mode, the IP phone's LCD display shows (BASIC) IDLE. No AltiWare switching features are available in this operating mode. However, the phone user can enter a destination IP address followed by #, and make an outgoing call through the IP network to reach AltiWare or another IP 710 phone. Also, the IP phone can accept incoming calls originating from AltiWare or another IP 710 phone.

Normal Operation

In normal operating mode, the IP 710 should have been registered with the phone server and logged in as an extension. The time and extension appear in the LCD screen and all phone features are enabled.

Note: To make the IP 710 work in normal operating mode, open the firewall port 10032 for the phone server. Refer to the *AltiWare OE/ACC System Installation & Administration Manual* or *ACM System Administration Manual* for information on other firewall ports for H.323.

Installation

This chapter describes local installation and remote installation of the IP 710 phone.

Important Notes for Plug and Play:

The plug and play feature enables the IP 710 phone to automatically discover the AltiServ IP address.

- To use the plug and play feature, the user's IP phone must be on the LAN with AltiServ.
- There can be only one AltiServ on the LAN.
- An instance of AltiGen GateKeeper needs to be running on the LAN and configured to point to the AltiWare system.
- GateKeeper Auto Discovery uses broadcast UDP packets, which work in the LAN or VPN environment, but not through the public IP network.
- The DHCP server must be up and running.

Local Installation

1. Gather network settings information (this information will be needed to configure the IP 710):
 - AltiWare server IP address
If you are not using GateKeeper Auto Discovery – needed for plug and play – you will have to manually configure the AltiServ IP address on your IP phones.
 - Is DHCP used?
If DHCP is not used, obtain the IP 710 phone's IP address from the system administrator.
 - Firewall information
See "Firewall Considerations" on page 48, if a firewall is being used in the AltiWare environment.

2. Ensure that there are enough IP addresses for all IP phones and that enough physical extension licenses are available.
3. If using plug and play, ensure that there is an available virtual extension with the IP extension feature enabled, and that dynamic IP address is selected.
4. In AltAdmin/ACM Admin, create an extension with **Enable IP Extension** checked.
5. Configure the IP 710 phone in AltAdmin/ACM Admin:
Select **Altigen IP Phone Configuration** from the AltAdmin/ACM Admin **Management** menu.

This opens the **IP Phone Configuration** window:



The left side of the IP Phone Configuration window displays all the IP phones that have been set up in the system. The following table describes the parameters on the General tab:

Parameter	Description
-----------	-------------

General Info	Lets you specify the IP address of the AltiServ system the IP 710 phone is connected to. The version of software associated with AltiServ is automatically displayed in the Version field.
---------------------	---

To allow the extension user to have password-protected configuration functionality from the phone itself, check the **Enable Configure Password** check box and assign a numerical password. When the extension user attempts to configure features, the user will need to enter the assigned password to proceed.

H.323	Lets you set the Jitter Buffer —the delay used to buffer voice packets received from the IP network—in milliseconds. The Jitter Buffer should be adjusted according to the WAN bandwidth allocated to data traffic.
--------------	--

To allow NAT support for the IP extension, check the **Enable NAT** check box.

Parameter	Description
Time Display	<ul style="list-style-type: none"> • Offset - a per phone-based configuration, allows the phone to display a different time, based on location. • Format - a per-phone-based configuration, allows the phone to display 24 hour or 12 hour (AM/PM).
Trunk Access Code	<ul style="list-style-type: none"> • Lets you set the digit required to enable a user to return an outside call from the Call Log. • The default trunk access code is the route access code, if it is set in AltiAdmin/ACM Admin. • This setting also appears on the phone's SYSTEM menu.
TFTP	<p>Lets you assign the TFTP Server to which the IP phone can connect for updating firmware when necessary. Enter the IP address of the TFTP Server in the Server field.</p> <p>To update IP phone image, the administrator can check the Reset IP Phone and Boot Download check box options to reset and download image to update the phone.</p>
Debug	When enabled, allows the IP 710 phone to connect to Telnet for debugging.

Note: The **Apply To** button works with the following parameters: General, H.323, TFTP (Server field only; Reset IP Phone and Boot Download options cannot be applied to multiple extensions), and Debug. This works only when the IP 710 is operating in Basic mode.

After creating IP extensions, and setting parameters on the General tab, go to the IP 710 tab:

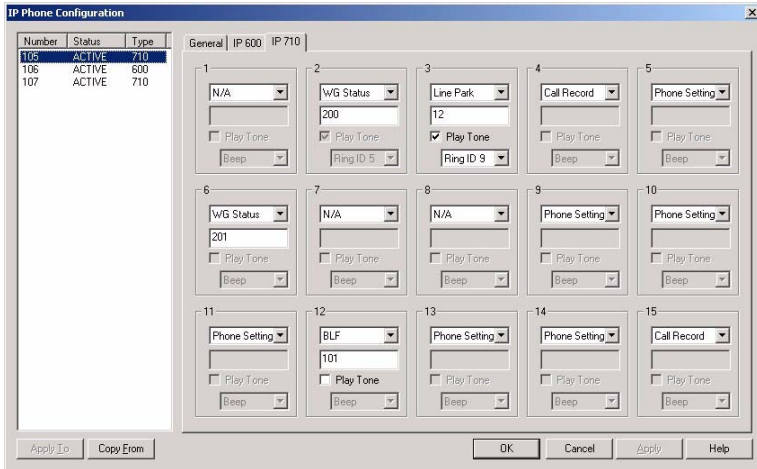

The parameters on the IP 710 tab are described in the next table.

Parameter	Description
Soft Keys 1 - 15	<p>Corresponds to the 15 soft keys on the IP 710. Use the drop-down list to assign one of the following functions to the desired keys:</p> <ul style="list-style-type: none"> • N/A - when selected, the corresponding soft key cannot be used. • BLF (Busy Lamp Field) - when selected, enter an extension number in the field below; this will be associated with the corresponding soft key to automatically dial this extension number; the light in this soft key indicates that the extension number is busy. You can select the Play Tone check box to also have the IP phone play an audible beep or one of 14 different ring tones when the extension number is ringing. <ul style="list-style-type: none"> Note: The BLF feature can be assigned only to <i>internal</i> extension numbers, not outside numbers. • Feature Code - when selected, enter an AltiServ feature code in the field below; this will be associated with the corresponding soft key to dial this feature code. • Speed Dial - when selected, enter the speed dial code in the field below; this will be associated with the corresponding soft key to dial this speed dial code. • Line Park - when selected, use the drop-down list to select the desired Line Park line ID.

Parameter	Description
-----------	-------------

Soft Keys
1 - 15
(cont.)

- **Call Record** - when selected, the IP phone user can start and/or stop voice recording on demand. In the **Extension Configuration** screen on the **General** page, **Record on Demand to Extension VM** or **Record on Demand to Central Location** must be enabled in the **Call Recording Options** field. Press the key to start recording, press the key again to stop recording. There is no pause function. When the call is recording, the light will be on. Recorded conversations can then be played back through voice mail or accessed at a centralized location.

WARNING!

Listening in to or recording a conversation without the consent of one or both parties may be a violation of local, state and federal privacy laws. It is the responsibility of the users of this feature to assure they are in compliance with all applicable laws.

- **Workgroup Status** - A workgroup number can be assigned that allows the IP 710 phone to display workgroup queue status, including number of calls in queue, longest queue time, agent login/logout state, number of calls exceeding service level threshold, and service level.
- **Phone Setting** - when selected, the IP phone user will be able to program the corresponding soft key as a speed dial or feature code key directly from the IP phone menu: **PHONE SETTING > PROGRAM KEYS > PROGRAM KEY**.

IMPORTANT!

The configuration in AltiWare will override the IP 710 phone's local configuration after the IP phone is registered. If the IP phone's local configuration is changed while in Basic mode, these changes will be overwritten by AltiAdmin/ACM Admin settings. Also, after the IP phone is successfully registered with the system, the IP phone will overwrite the AltiWare IP address and network-related settings on the server.

6. Connect the IP 710:
 - a. Connect the phone to the LAN that AltiServ is on.
 - b. Connect the handset to the handset port.
 - c. Connect an Ethernet cable from another network device, such as a desktop computer, to the PC access port on the phone (optional).
 - d. Connect the power plug to the DC port.

Note: If you want to use Power over Ethernet, see “To Use IP 710 in Power over Ethernet Mode” on page 21.

7. Configure startup network settings:

If you are using DHCP, ensure that DHCP is enabled on the IP 710 phone: **Menu** > NETWORK > ENABLE DHCP > Yes. (DHCP is enabled by default.)

If you are *not* using DHCP, you must configure these network settings on the IP 710 after installing the phone on the network:

- Local IP address
- IP subnet mask
- Gateway IP address

8. Configure the AltiWare IP settings:

If you are using GateKeeper Auto Discovery, you do not need to configure anything. Proceed to Step 9.

If you are *not* using GateKeeper Auto Discovery, you must manually configure the AltiWare IP address setting into the IP 710 phone:

- a. **Menu** > SYSTEM > **Enter**.
- b. Select AW SERVER, and press **Enter**.
- c. Enter the AltiWare server address, using the * key to input periods, and press **Enter**.

9. Activate the IP 710 extension from the IP phone:

- a. With the handset onhook, press **#27**, then the **Enter** button.
- b. Enter the extension number and password when prompted.

c. The phone will attempt to register, as shown in the LCD screen:



If the phone successfully passes through these stages, the phone shows the time and extension in the LCD screen and is now in normal operating mode.

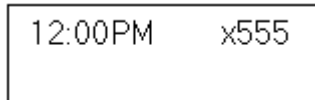

Otherwise, refer to “Troubleshooting” on page 49.

Remote Installation

To install the IP 710 phone at a remote location, using a broadband connection with or without a router:

1. Check the firewall settings at the corporate network to open TCP/UDP ports required by the IP 710. (For more information on firewall settings, refer to “Firewall Considerations” on page 48.)
2. Check the AltiWare server’s IP extension settings (make sure the IP extension is enabled, enough physical extension licenses are available, etc.)
3. If DHCP is not used, configure the phone’s local IP address and Gateway IP address. (Depending on the Internet Service Provider’s recommendations, you may or may not want to use DHCP.)
 - a. Press the **Menu** button, scroll to NETWORK, and press the **Enter** button.
 - b. Scroll to LOCAL ADDRESS, then press **Enter**.
 - c. Enter the IP address, using the * key to input periods, then press **Enter**.
4. If a NAT server is used, return to the NETWORK menu and set the ENABLE NAT setting to YES.
5. If configuring with an H.323 NAT router, the NAT router can forward IP traffic to a specified private IP address based on the destination port in the TCP/IP or UDP packets. When an H.323 endpoint is

behind the H.323 NAT, you should set up the forwarding to a private IP address of this H.323 endpoint.

If this H.323 endpoint is AltiWare, the NAT router must be configured to forward the following ports to the H.323 endpoint's private IP address:

- TCP port 10032 (for phone service)
 - TCP port 1720 (for H.225)
 - TCP/UDP 49152 ~ N (for H.245 and RTP/RTCP); where $N = 49152 + (62 * \text{number of VoIP boards}) - 1$.
6. Configure the IP 710 phone's AltiWare address:
 - a. Press the **Menu** button, scroll to **SYSTEM**, and press **Enter**.
 - b. Select **AW SERVER**, and press **Enter**.
 - c. Enter the AltiWare server address, using the * key to input periods, and press **Enter**.
 7. Exit the menu, using the **Release** button or the ◀ button.
 8. Press **#27** then press **Enter** to initiate logging onto AltiServ.
 9. The phone will attempt to register as shown in the LCD screen.



REGISTERING...

If the phone successfully passes through these stages, the phone shows the time and extension in the LCD screen and is now in normal operating mode.

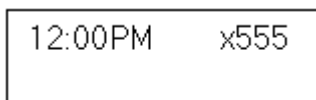

12:00PM x555

Otherwise, refer to “Troubleshooting” on page 49.

Note: The IP 710 AltiWare IP address, TFTP (IP) address and other network-related configuration parameters will override the AltiAdmin's settings when the phone registers with AltiServ. Other parameters will still be overridden by the AltiAdmin settings as before.

10. Set up IP phone properties in AltiWare as described in step 5 on page 10.

Verifying the Phone Startup Process

After the IP 710 has power connected to it, the phone begins its automatic booting process by cycling through these steps:

1. All LED lights will be on.
2. The LCD screen displays [ATGN BOOT] on the first line.
3. On the second line of the LCD screen, the following messages are displayed in succession:
 - CHECK MEMORY (RAM checking state)
 - CHECK FW (Firmware checking state)
 - INIT NETWORK
 - LOADING FW . . .
 - LOADING NOW .
 - Boot Done
 - INITIALIZING

Resolving Errors Upon Startup

If an error occurs during booting, the LED light of the following soft keys will remain on to indicate an error status. These errors represent hardware failures within the IP Phone.

- Intercom LED light on = memory check failed
- Handset LED light on = network failed
- Conference LED light on = DHCP failed
- Hold LED light on = attached IP address failed

If the phone successfully passes through these stages, it has started up properly. Otherwise, refer to “Troubleshooting” on page 49.

Other Phone Already Logged On To Extension

If another analog phone or IP phone is already logged on to the same extension, rebooting the IP 710 will not register the phone successfully. The user must press **#27** on the IP phone to actively log on to Altiserv. After the extension is logged on and activated, the calls are redirected to this IP Phone.

Important: The user should not use the VM option to log on to the IP 710 phone.

Executing Plug and Play *After* IP Phone is Started

If you have already started the IP phone and want to execute the plug and play feature, perform the following steps:

1. Power up the IP phone (the phone should be in Basic mode).

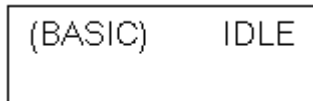

2. Press the **Menu** button.
3. Press ****2** then the **Enter** button to restore default settings.
4. Reboot the phone (by unplugging the power and replugging OR pressing ****3** then **Enter**).
5. Enter extension number and password.
6. The time and extension are displayed in the first line of the LCD screen after the phone has been successfully logged on to Altiserv.

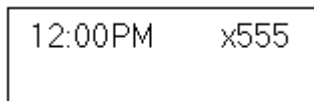

Restoring Default Settings

To automatically restore the original default settings for the IP 710 phone:

1. Press the **Menu** button.
2. Press ****2**, then press the **Enter** button.

Rebooting the IP 710 Phone

To reboot the IP 710, press * * 3, then press the **Enter** button.

Note: When the IP 710 is rebooted, the AltiWare IP address setting reverts to the original configuration.

To Use IP 710 in Power over Ethernet Mode

1. Unplug the power cord.
2. Remove the screw on the PoE Module cover, and remove the cover.
3. Plug in the PoE Module as illustrated below. The side with four pins in the *middle* faces the top.

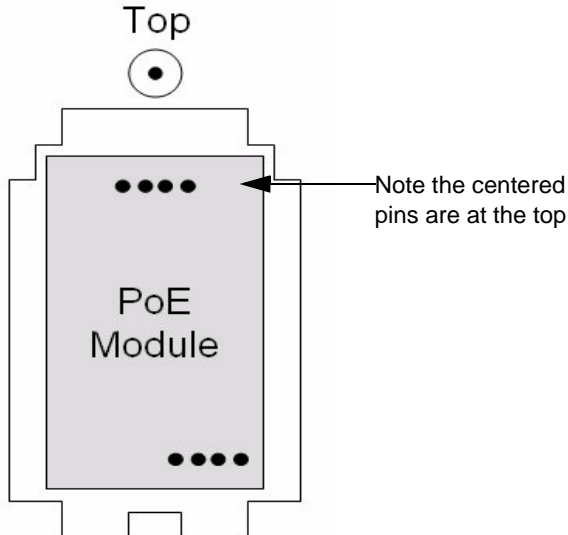

4. Put the PoE module cover back, and tighten the screw.
5. Move the DC/PoE switch to the PoE position.
6. Connect the phone to an AltiGen-certified PoE-enabled switch.

To Remove the PoE Module

1. Remove the screw on the PoE Module cover, and remove the cover.
2. Notice the “feet” on the two tabs that are on the lower end of the cover. Use these feet to lift the PoE module out of the compartment, like this: Holding the upper end of the cover, slip the cover into either the right side or left side of the module compartment, between the compartment and the module, until the feet of the two tabs is under the module (the inside of the cover should be facing toward the module).
3. Pull up to remove the module.

Operation Notes

- When using #26 and #27 to log out/in, the IP 710 must be onhook. Using the **Speaker** button to use #26 or #27 will not work.
- Two dial tones are always heard when going offhook on the IP 710.
- If two calls ring into the IP 710 at the same time and the user attempts to answer the second call, the IP phone will automatically connect the user to the first call.
- If the IP 710 is configured for a public IP address, you can call other public IP address devices.
- If the IP 710 is configured for a private IP address, you can call other private IP address devices that you can “see” or that are on your subnet.
- The daisy chaining of IP 710 phones is not supported.
- While the phone’s menu is being used, incoming calls will be directed to the extension’s busy call handling setting.

Phone Configuration

Phone, system, and network settings can be configured through the IP phone's menu. The phone can also be registered through this menu, if necessary.

- To get to the menu, press the **Menu** button.
- ▲/▼ buttons scroll the menus and settings in the LCD screen.
- ▶ button selects a menu item or a setting.
- The **Enter** button also selects a menu item or a setting.
- ◀ button returns to the previous menu.
- Press the **Release** button to exit the menu.

The following tables describe each setting and the corresponding menu path.

Important: The configuration in AltiAdmin will override the IP 710 phone's local configuration after the IP phone is registered. If the IP phone's local configuration is changed while in Basic mode, these changes will be overwritten by AltiAdmin settings. Also, after the IP phone is successfully registered with AltiServ, the IP phone will overwrite the AltiWare IP address and network-related settings on the server.

Note: Several of these settings can be configured through AltiAdmin by the system administrator.

Phone Settings

Setting	Menu Path	Description
Extension Number	Phone Setting > Ext Number	Sets the IP phone's extension number.
Extension Password	Phone Setting > Ext Password	Sets the IP phone's extension password.

Program Keys	Phone Setting > Program Keys > Program Key [#]	Sets the speed dial number or feature code for a selected key.
Ring Tone	Phone Setting > Ring Tones	Sets the desired ring tone.
Auto Answer	Phone Setting > Auto Answer	Sets whether to enable automatic answering.
Auto Answer Ring	Phone Setting > Auto Ans Ring	Sets how many seconds the phone should ring before it is automatically answered. Appears on menu when Auto Answer is set to Yes.
Auto Answer Device	Phone Setting > Auto Ans Dev	Sets whether speaker or headset is the automatic answering device. Appears on menu when Auto Answer is set to Yes.

System Settings

Setting	Menu Path	Description
AltiWare Server	System > AW Server	Sets the AltiWare server's IP address.
Trunk Access Code	SYSTEM > TRK ACCESS CODE	Sets the digit required to enable a user to return an outside call from the Call Log.
Hour Offset	System > Hour Offset	Sets the time offset from the AltiWare server's time.
TFTP Server	System > TFTP Server	Sets the TFTP server IP address for updating firmware.
Boot Download	System > Boot Download	After firmware image upgrade, this setting changes to No. Used mainly for upgrading or troubleshooting. On the next boot, the IP phone will download the new firmware from the TFTP server, if set to Yes.

Emergency Number	System > Emergency Num	Sets the IP phone's emergency number. For the U.S., the emergency number is 911.
Emergency Gateway	System > Emergency GW	Sets the IP phone's emergency gateway IP address
Version Information	System > Version Info [Read only]	Displays the version number of the IP phone.

Network Settings

Setting	Menu Path	Description
Enable DHCP	Network > Enable DHCP	Sets whether Dynamic Host Configuration Protocol (DHCP) is being used by the IP phone to retrieve a new IP address upon boot up.
Local Address	Network > Local Address	Sets the IP phone's local address; shows only if DHCP is disabled.
Network Mask	Network > Network Mask	Sets the IP phone's network mask; shows only if DHCP is disabled.
Gateway	Network > Gateway	Sets the default Gateway IP address.
Enable GateKeeper	Network > Enable GK	Sets whether GateKeeper is enabled or disabled.
GateKeeper Discovery	Network > GK Discovery	Sets whether GateKeeper discovery is enabled. IP phone will automatically find GateKeeper. Shows only if GateKeeper is enabled.
Enable NAT	Network > Enable NAT	Sets whether NAT is enabled or disabled.
NAT Address	Network > NAT Address	Sets the NAT server's public IP address.

Registration

Under normal circumstances, the IP 710 phone registers itself automatically. However, if registration failed for some reason (for example, the server was not available), registration can be started again from the IP 710 phone's menu:

1. Press the **Menu** button.
2. Scroll to REGISTER.
3. Press the **Enter** button.

Enabling/Disabling DHCP

Dynamic Host Configuration Protocol (DHCP) automatically assigns IP addresses to devices when they are connected to the network. The IP 710 enables DHCP by default. If you do not use DHCP in your network, you can disable DHCP before manually assigning an IP address to the IP 710.

Note: Procedures involving configuring IP settings cannot be completed when DHCP is enabled on the IP phone.

To enable/disable DHCP, follow these steps:

1. Press the **Menu** button.
2. Press the ▼ button to select NETWORK, then press the **Enter** button.
3. Scroll to ENABLE DHCP, then press **Enter**.
4. Press ▲/▼ to toggle to YES or NO and press **Enter**.
5. Restart the phone to obtain IP confirmation information from the DHCP server

Configuring IP Settings

Use these guidelines when manually configuring the IP settings:

- Ensure the default gateway IP address is on the same subnet as the host IP address.
- When inputting IP addresses into the IP 710, use the * key to enter periods. For example, 209.120.12.8 would be input as 209*120*12*8.

Assigning a Local IP Address

The IP address is the unique logical address identifying each host computer on a TCP/IP network. An IP address is a 32-bit number expressed as four decimal numbers from 0 to 255, separated by periods.

To assign an IP address, use the following steps:

1. Ensure that DHCP is disabled (refer to “Enabling/Disabling DHCP” on page 26).
2. Press the **Menu** button, scroll to NETWORK, then press the **Enter** button.
3. Scroll to LOCAL ADDRESS, and press **Enter**.
4. Use the keys on the dial pad to enter a new IP address, using the * key to enter periods.
5. Press **Enter**.

Assigning a TFTP Server

The default TFTP Server is set to 0.0.0.0.

To assign the TFTP server, use the following steps:

1. Press the **Menu** button.
2. Use ▲/▼ to select **System**, then press the **Enter** button.
3. Scroll to **TFTP Server**, and press **Enter**.
4. Use the keys on the dial pad to enter the new TFTP server address, using the * key to enter periods, then press **Enter**.

Updating Phone Firmware

Note: If using TFTP Server Application, TFTP32, included in the CD-ROM, copy `tftpd32.exe` and the associated `.hlp` and `.gid` files to a local directory; after they are copied, you can launch the TFTP Server application from the executable file.

Obtain `app_710.bin` and `dsp.bin` files from the AltiGen website and copy to the same local directory where you copied `tftpd32.exe`.

Important: When updating the IP 710 phone's firmware, it is recommended that administrators perform any updates *after* normal business hours or when the IP phone is not in use. If the IP 710 phone is in use during an update, the call will be disconnected.

If the IP 710 phone is registered with AltiServ, to update the phone firmware from AltiAdmin, do the following:

1. Launch IP Phone Configuration in AltiAdmin Main Menu.
2. Set the TFTP Server address.
3. Select **Boot Download** and **Reset IP Phone** check boxes, then click **Apply**.
4. The IP 710 should reboot and download the image from the specified TFTP server.

To update the phone firmware directly from the IP 710 phone, follow these steps:

1. Press the **Menu** button.
2. Use the ▼ button to scroll to *System*, then press the **Enter** button.
3. Scroll to *TFTP Server*, then press **Enter**.
4. Enter the TFTP server address, using the * key to input periods.
5. The IP 710 will download the firmware from the TFTP server on the next reboot.
6. Reboot by unplugging and replugging the power cable OR by pressing * * 3 and the **Enter** button.
7. Once the IP phone is rebooted, all LED lights come on for a brief time.
8. The LCD screen displays [BOOTING] on the first line.
9. On the second line of the LCD screen, the following messages are displayed in succession:
 - CHECK MEMORY (RAM checking state)
 - CHECK FW (Firmware checking state)
 - INIT NETWORK
 - LOADING FW . . .
 - LOADING NOW.

—Boot Done

—INITIALIZING

10. You may verify the new version of firmware: Press the **Menu** button, scroll to **SYSTEM** and press **Enter**, scroll to **Version Info** and press **Enter**.

Resolving Errors Upon Rebooting

If an error occurs during rebooting, the LED light of the following soft keys will remain on to indicate an error status. These errors represent hardware failures within the IP 710 phone.

- Intercom LED light on = memory check failed
- Headset LED light on = network failed
- Conference LED light on = DHCP failed
- Hold LED light on = attached IP address failed

If the phone successfully passes through these stages, it has started up properly. Otherwise, refer to “Troubleshooting” on page 49.

Configuring NAT

NAT (Network Address Translation) is the translation of an IP address used within one network to a different IP address known within another network. One network is designated as the inside network, the other is the outside. The IP 710 can be enabled to support H.323 behind NAT. The IP 710 will be able to work behind a regular NAT router without any special implementation for H.323.

For more detailed information regarding NAT configuration guidelines and implementation, refer to the *AltiWare OE/ACC* or *ACM System Administration Manual*.

Note: If more than one IP 710 phone sits behind NAT, a VPN tunnel is required to connect between the NAT router and the corporate router.

Enabling NAT

By default, NAT is not enabled. If you connect the IP 710 behind a NAT router, you must enable NAT.

To enable NAT,

1. Press the **Menu** button.
2. Use the ▼ button to scroll to NETWORK, then press the **Enter** button.
3. Scroll to ENABLE NAT, and press **Enter**.
4. Press ▼ to select YES, and press **Enter**.

Setting Ring Tones

The IP 710 phone has 14 ring tones available. To set the ring tone:

1. Press the **Menu** button.
2. Select PHONE SETTING, then press the **Enter** button.
3. Scroll to RING TONES and press **Enter**.
4. Scroll to desired ring tone and press **Enter**.

Distinctive Ringing Support

If the **Distinctive Ring** options are enabled by the system administrator in AltAdmin/ACM Admin (**General** page of **System Configuration**), you may have three different ring cadences that distinguish the types of calls:

- Internal call = 1 ring
- External call = 2 ring
- Operator call = 3 rings

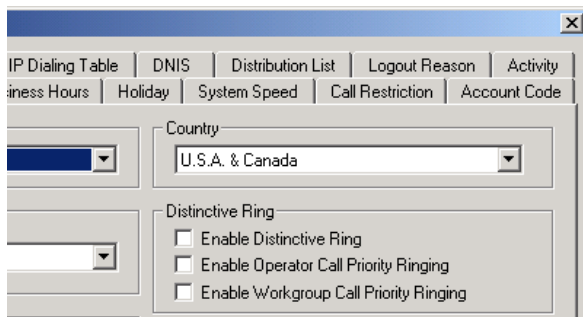

Figure 4. Distinctive Ring Options, General Page, System Configuration

Workgroup Status Display

A programmable key can be configured in AltAdmin/ACM Admin to display workgroup status when the key is pressed. The workgroup status display is in the following format:

WG 200	CIQ 05	LQT 05
LOGIN	>TH 02	SL 060

WG - workgroup number

CIQ - number of calls currently in the queue

LQT - longest queue time of current queued calls

LOGIN - LOGIN/LOGOUT indicates the agent login/logout state

TH - number of calls in the queue whose queue time is greater than the service level threshold

SL - service level in percentage

Greeting Button

The IP 710 phone's **Greeting** button is a shortcut to the greeting feature in voice mail. It lets users:

- Record a greeting
- Enter a directory name
- Select which greeting to use

Greetings are affiliated with activity codes. The user can choose, for example, the “meeting” greeting or the “business travel” greeting. See “Activity Button,” below.

Activity Button

The IP 710 phone's **Activity** button lets users select an activity code that corresponds to their activity status (for example, at a meeting or in training). The selected code appears in the upper right of the LCD screen.

When an IP 710 user calls an extension in the system that has activity codes set up and the call goes into RNA handling, or the destination user has DND enabled, the activity code is displayed on the IP phone.

Note: Called party activity display is not available in Basic mode. Also, the activity displayed on the IP phone may truncate the caller ID/caller name.

The administrator can change the activity codes in Alti Admin/ACM Admin in the System Configuration dialog box, Activity tab.

To select an activity code from the IP 710 phone:

1. Press the **Activity** button.
2. Press ▼/▲ to scroll through the codes.
3. Press **Enter** to select a code.

Phone Functions

The IP 710 provides a broad range of call handling and dialing features directly on the phone and through the AltiWare system. The table in “Supported Telephony Features” on page 34 lists the supported features, a brief description of each, and configuration and use notes where applicable.

The LCD Screen

In normal operating mode, the phone’s LCD screen displays the time and the extension number on the first line:

12:00 PM	x555
DND	MISSED xx 3VM

If an activity code has been set on the phone, that code is displayed in place of the extension number. Examples of activity codes are MEETING, AWAY, TRAVEL.

Other messages you may see:

DND or FWD - The extension has Do Not Disturb on or is set to forward all calls.

MISSED xx - Number of calls missed.

VM - Indicates the number of new voice messages.

Workgroup Status Display

When the administrator has configured a soft key to display workgroup status when pressed, the workgroup status display is in the following format:

WG 200	CIQ 05	LQT 05
LOGIN	>TH 02	SL 060

WG - Workgroup number.

CIQ - Number of calls currently in the queue.

LQT - Longest queue time of current queued calls.

LOGIN - LOGIN/LOGOUT indicates the agent login/logout state.

TH - Number of calls in queue whose queue time is greater than the service level threshold.

SL - Service level in percentage.

Supported Telephony Features

The following table lists additional features supported by the IP 710 phone.

Feature	Description	Configuration/Use Notes
Activity button	Lets users set an activity code that specifies their activity status (for example, in a meeting) when they are not at the phone.	<ul style="list-style-type: none">• Callers in the system are notified of the activity status when a call is not answered.
Auto Answer	When a call comes in, the IP phone will ring for a specified number of seconds, connect the call, and automatically answer through the speaker or headset.	<ul style="list-style-type: none">• Phone's menu path: PHONE SETTING > AUTO ANSWER.• During ringing, the user can manually pick up the call from headset, handset or speaker.
Auto Answer Ring	When Auto Answer is set to Yes, specifies how many seconds the IP phone should ring before the call is automatically answered (1-20 seconds).	<ul style="list-style-type: none">• Phone's menu path: PHONE SETTING > AUTO ANS RING. Number of seconds can be set using ▲/▼, or using the keypad to enter a number (1-20).
Auto Answer Dev	When Auto Answer is set to Yes, specifies whether the call should be automatically answered through the speaker or headset.	<ul style="list-style-type: none">• Phone's menu path: PHONE SETTING > AUTO ANS DEV. Pressing ▲/▼ toggles SPEAKER/HEADSET.

<p>Busy Lamp Field (BLF)</p>	<p>Associates soft key with an extension that can be automatically dialed when selected; the key's light indicates that the extension is busy and blinks when ringing.</p> <p>The BLF ring tone is played only when the phone is in idle state. It is stopped when the destination phone stops ringing or the local phone exits idle state.</p> <p>When multiple BLF extensions ring simultaneously, the IP phone will play the first BLF extension ringer and beep tones and ignore other BLF extensions.</p>	<ul style="list-style-type: none"> • From AltiAdmin/ACM Admin, go to AltiGen IP Phone Configuration on the Management Menu, go to the desired extension, and set the appropriate function key to BLF and enter the extension in the field below. The extension will be associated with the corresponding soft key to automatically dial this extension number. Select the Play Beep Tone checkbox to have the IP phone play an audible beep or one of 14 different ring tones when the extension is ringing. • The BLF feature can be assigned only to <i>internal</i> extension numbers, not outside numbers. • The feature is not available in Basic mode.
<p>Call Log</p>	<p>Shows the history of incoming calls, up to 99.</p>	<ul style="list-style-type: none"> • Feature does not require special configuration to work.

Call Record	Allows this key to be used for on-demand recording.	<ul style="list-style-type: none"> • From AltiAdmin/ACM Admin, go to AltiGen IP Phone Configuration on the Management Menu, go to the desired extension, and set the appropriate function key to Call Record. • Go to the Extension Configuration screen, General page. In the Call Recording Options field, select Record on Demand to Extension VM or Record on Demand to Central Location. • User presses the key to start recording, presses the key again to stop recording. There is no pause function. When the call is recording, the light is on. • Recorded conversations can then be played back through voice mail or accessed at a centralized location.
Conference button	Initiates a conference and adds in other parties one at a time.	<ul style="list-style-type: none"> • Single Call Waiting, Multiple Call Waiting or Live Call Waiting must be enabled in AltiAdmin/ACM Admin in order to conference incoming calls. • The user who initiates the conference call can select another conference member's call and drop it from the conference by disconnecting the call. The feature is unavailable to all other conference members, even when the conference initiator hangs up.
Workgroup Status	Displays the workgroup status in the LCD.	<ul style="list-style-type: none"> • From AltiAdmin/ACM Admin, go to AltiGen IP Phone Configuration on the Management Menu, go to the desired extension, select IP 710 tab, select WG Status from programmable key drop-down list, and enter a workgroup number.

Flash button	Signals PBX that special instructions will follow.	<ul style="list-style-type: none"> • Press the Flash button.
Greeting button	Lets user record greetings and select a greeting to play.	<ul style="list-style-type: none"> • Greetings are affiliated with activity codes.
Headset button	When pressed, the user will be able to activate a third-party headset (certified by AltiGen).	<ul style="list-style-type: none"> • This button is used as a hook switch for headset ports.
Hold button	Places an active call on hold.	<ul style="list-style-type: none"> • When multiple Call Waiting Feature is enabled at the extension, the user can put multiple incoming calls on hold and retrieve using the phone's ▲/▼ buttons and Enter button. • Pressing Hold while onhook will retrieve the last hold call. • Supports up to 9 hold calls.
Intercom button	Connects you directly to the callee's intercom after one ring.	<ul style="list-style-type: none"> • Feature does not require special configuration to work.

Line Park	A parked call line appearance can be assigned as a programmable “ Parked Call Line ” key by the administrator. When connected to a caller, the call can be parked by pressing the Parked Call Line key. If a call is parked at a Parked Call Line, the button’s light is on. The call can be picked up by pressing the Parked Call Line key.	<ul style="list-style-type: none"> • Go to AltiGen IP Phone Configuration on the Management Menu, go to the desired extension, and set the appropriate function key to Line Park. • When configured by the administrator, the IP phone can play an audible beep or one of 12 different ring tones when a call is parked. • When configured by the administrator, an <i>alternate</i> way to pick up a parked call is to use #51 <line number> if Line Park is not assigned to a soft key. • The Parked Call Line key’s light will be lit and turns off when the parked call is picked up, the caller hangs up, or the call is routed to IVR/Auto Attendant.
Mute button	While on a call, mutes conversation.	<ul style="list-style-type: none"> • Feature does not require special configuration to work.
Program Soft Keys	Lets users associate a soft key with a speed dial number or feature code directly from the IP phone.	<ul style="list-style-type: none"> • In AltiAdmin, go to AltiGen IP Phone Configuration on the Management Menu, go to the desired extension, and set the appropriate function key to Phone Setting. The user will be able to configure this key from the IP phone menu, under PHONE SETTINGS > PROGRAM KEYS.
Redial button	Redials a selected number from the last 16 numbers dialed.	<ul style="list-style-type: none"> • Feature does not require special configuration to work. • Redials up to 32 digits.
Release button	Releases a call from the connected state. Deletes characters entered on the LCD. While onhook, releases phone from an active state.	<ul style="list-style-type: none"> • Feature does not require special configuration to work.

Ring Tones	Select from one of 14 ring tones.	<ul style="list-style-type: none"> Phone's menu path: PHONE SETTING > RING TONES, and select from 0 - 13.
Soft Keys 1 - 15	Key performs a specified function (Busy Lamp Field, Altiserv Feature Code, Speed Dial, Line Park, Call Record, Workgroup Status, or Phone Setting) previously configured by the system administrator.	<ul style="list-style-type: none"> In AltAdmin, go to Altigen IP Phone Configuration on the Management Menu, select the desired extension, and set the appropriate soft key to the desired function (Phone Setting lets the user associate a soft key with a speed dial number or feature code).
Speaker button	Enables use of speaker phone.	<ul style="list-style-type: none"> Feature does not require special configuration to work.
Speed Dial button	Quickly dials a selected number from a list that has been previously stored.	<ul style="list-style-type: none"> In AltAdmin, go to Extension Configuration > Station Speed and enter the Speed Dial numbers for the appropriate extension(s).
Transfer button	Transfers an active call to another number.	<ul style="list-style-type: none"> Feature does not require special configuration to work. This button cannot be used to "flash" after being used to transfer a call. To reconnect to a call after using the Transfer button, use the ◀ button or the Flash button.
Voice Mail button	Enables access to voice messages.	<ul style="list-style-type: none"> The VM count that appears in the LCD reflects new messages (previously heard messages are not included).

Glossary

A

ASCII - American Standard Code for Information Interchange.

B

Boot - to cause the computer to start executing instructions.

BPS - Bits Per Second. The number of bits transmitted per second.

C

configure - to determine and assign the equipment cabinet or chassis contents and location of each card, as well as software parameters.

D

DHCP (Dynamic Host Configuration Protocol) - a protocol that lets network administrators manage centrally and automate the assignment of Internet Protocol (IP) addresses in an organization's network.

DNS - Domain name system used to address translation to convert H.323 IDs, URLs, or e-mail IDs to IP addresses. DNS is also used to assist in locating remote gatekeepers and to reverse-map raw IP addresses to host names of administrative domains.

Do Not Disturb (DND) - when this feature is selected, all incoming calls to the user's extension are denied. If the station has system forwarding instructions, the calls will be automatically redirected to another extension, Attendant, or operator.

DTMF - Dual Tone Multi Frequency are the low and high frequency tones that comprise touch tone signals.

DSP - Digital Signal Processor. A microprocessor with an architecture that is particularly optimized to perform mathematical algorithms that manipulate digital signals.

Dynamic IP Address - An IP address that is automatically assigned to a client station in a TCP/IP network, typically by a DHCP server. Network devices that serve multiple uses, such as server and printers, are usually assigned static IP addresses.

Dual Tone Multi Frequency - see DTMF.

E

extension number - an arbitrary number of two to five digits that matches a station to a particular user.

F

Firewall - a set of related programs, located at a network gateway server, that protects the resources of a network from users of other networks.

FLASH - a sudden brief signal. Activated by pressing the **Flash** button, or by a quick press and release of the receiver button (switch hook).

FXS - Foreign Exchange Subscriber. An analog interface for direct connection of a telephone set to a digital multiplexer.

G

Gateway - allows H.323 terminals to communicate with terminals configured to other protocols by converting protocols. A gateway is the point where a circuit-switched call is encoded and repackaged into IP packets.

GMT - Greenwich Mean Time. Mean solar time of the meridian at Greenwich, England, used as the basis for standard time throughout the world.

H

H.323 - An International Telecommunications Union (ITU-T) standard that describes packet-based video, audio and data conferencing.

http or HTTP - Hypertext Transfer Protocol. The Internet protocol used to manage communications between Web clients (browsers) and servers.

I

IMAP4 - Internet Message Access Protocol - Version 4.

IP 710 - An AltiGen H.323-compliant, business telephone that provides voice communication over an IP network.

IP Address - a 32-binary digit number that identifies each sender or receiver of information that is sent in packets across the Internet.

ISP - Internet Service Provider.

J

jack - the mate for a plug. Used to connect two pieces of equipment together.

K

keyboard - system interface for communication. A group of numeric keys, alphabetic keys, or function keys used for entering information into a terminal and into the system.

L

Local address - an address used in a peripheral node or station in place of a network address and transformed to or from a network address for delivery purposes.

Logoff - the procedure by which a user disconnects from a program or session.

Logon - the procedure by which a user begins a program or terminal session and gains access to the Altiserv or Quantum system.

M

MHz - Megahertz.

ms - millisecond.

N

NAT (Network Address Translation) - translation of an Internet Protocol address (IP address) used within one network to a different IP address known within another network. One network is designated the inside network, the other is the outside.

network - A configuration of data processing and/or telecommunication devices and software connected for information exchange.

network address - An identifier for a node, station, or unit of equipment in a network.

network domain - a set of workstations and servers that share a security account manager database and can be administered as a group. A user with an account in a particular network domain can log onto and access his or her account from any system in the domain.

network mask - also known as the subnet mask.

network server - networking software that responds to I/O or computes requests from a client machine. Windows NT network servers can be implemented either as server processes or as drivers.

O

offhook - refers to the phone when the receiver is not resting in the base.

One Number Access - a feature of AltiWare that allows users to create a list of phone numbers that the system can use to track users and connect them with an incoming call if they are not at their extension desk.

onhook - the term used to describe a telephone in the idle state or with the receiver still resting in the base.

P

physical extension - is associated with a physical port and device. An extension is created, by default, as a physical extension (as opposed to a virtual or workgroup extension) unless there are no more physical ports available.

ping (Packet InterNet Groper) - a program used to test whether a particular network destination on the Internet is online by repeatedly bouncing a signal off a specified address.

port - a communication channel through which a client process communicates with a protected subsystem.

protocol - A set of rules and conventions by which two computers pass messages across a network medium. Networking software generally implements multiple levels of protocols layered one on top of the other.

Q

queue - a collection of calls waiting to be served. Queued calls in AltiWare are handled on a first-in, first-out basis.

R

RAS - Remote Access Service.

RJ-11 - The common telephone jack. Usually wired with four wires, the red and green signify the tip and ring circuits.

RJ-45 - A jack for data cables. Usually wired with eight wires.

router - protocol-dependent device that connects subnetworks together.

S

server - any computer whose function in a network is to provide user access to files, printing, communication, and other services.

static IP address - a permanent IP address that is assigned to a node in a TCP/IP network.

subnet mask - the method used for splitting IP networks into a series of subgroups, or subnets. The mask is a binary pattern that is matched up with the IP address to turn part of the host ID address field into a field for subnets.

System Speed Dialing - this feature allows the user to access a list of commonly called phone numbers entered into the system by the administrator. The user presses the **SpeedDial** button on the phone, selects a number from the list, and then dials by pressing the **Enter** button.

T

TCP/IP - Transmission Control Protocol/Internet Protocol. A full set of protocols used on the Internet.

TDM - Time Division Multiplexing.

TFTP (Trivial File Transfer Protocol) - a version of the TCP/IP FTP protocol that has no directory or password capability.

transfer - this feature redirects a call to another extension, the AltiGen Voice Mail System, or operator.

U

UDP (User Datagram Protocol) - a communications protocol that offers a limited amount of service when messages are exchanged between computers in a network that uses the Internet Protocol.

URL (Uniform Resource Locator) - the address that defines the route to a file on the web or any other Internet facility.

user(s) - the person or persons accessing the features and functions of the AltiWare product.

V

virtual extension - an extension not associated with a physical port that allows for guest access to the AltiGen Voice Mail System features and telephone sharing environments. Users of a virtual extension have to log in before accessing the system features assigned to it.

VoIP - voice over Internet Protocol (IP). The technology used to transmit voice conversations over a data network using the Internet Protocol.

W

workgroup - telephones arranged in groups within a particular organizational function (for example, marketing, sales, service, etc.). Each workgroup is assigned a pilot number. When the pilot number is dialed, the system scans the list of extensions comprising the workgroup and connects the call to the first available idle extension number. If no extensions are available, the call is placed in that workgroup's queue.

workgroup pilot number - an extension designated to a workgroup that is not associated with a physical port and may consist of up to 64 members. When the pilot number is dialed, the call is distributed to the workgroup members.

Appendix A

Specifications

Network Protocols	<ul style="list-style-type: none">• H.323, RTP, RTCP, TFTP, TCP, UDP, DHCP, DNS, ARP, ICMP, Telnet
Call Control Protocols	<ul style="list-style-type: none">• H.323
Audio Standards	<ul style="list-style-type: none">• Vocoder: ITU G.711 (PCM), two low bit rate (G.723.1 and G.729A / G.729AB)• Acoustic Echo cancellation supporting high-quality speakerphone
Keypad Features & Handset	<ul style="list-style-type: none">• 12 standard dialing keys: 0-9, *, #• 11 Feature keys: Greeting, Activity, Voice Mail, Redial, Speed Dial, Call Log, Flash, Transfer, Intercom, Conference, Hold.• 15 Function keys: can be set to Busy Lamp Field, AltiServ feature code, speed dial, line park, call recording, workgroup status.• Adjustable Speaker/Ring/Handset/Headset volume control
LCD	<ul style="list-style-type: none">• 4 x 20 Character LCD Display• Provide features such as time, calling party name, calling party number, digits dialed, extension number, number of new voice mails, DND/FWD, missed calls, and system information.
LED	<ul style="list-style-type: none">• Hold, Mute, Speaker, Conference, Headset, Intercom.• Message waiting indicator
LAN	<ul style="list-style-type: none">• 2 Standard 10/100 Base-T RJ-45 Ports: One for network to phone connection, and one switch port for connection from phone to PC
Memory	<ul style="list-style-type: none">• Flash ROM: 4M, stores boot ROM, software imaging and configuration data, DSP images.• DRAM: 8M, stores runtime program and data.

Firewall Considerations

Headset

- Headset RJ-10 port
- Headset 2mm plug receptacle

Important: Contact AltiGen for the most current list of certified headsets.

The pin outlet for headset support is:

Pin 1 (Tx-), Pin 2 (Rx1), Pin 3 (Rx2), Pin 4 (Tx+)

Note: If using Plantronics H91N or H101N headsets, a separate Plantronics cable should be used and must be ordered separately (part # 27190-01) in order to plug in these headsets to the headset port.

Dimensions

- 210 x 175 x 75 mm

Power

- External power, 5VDC, 1.5A
 - PoE option
-

Firewall Considerations

If using a firewall in the AltiWare environment, the following network ports are used:

Client	Server	TCP	UDP
AltiAdmin ^a	AltiWare DCOM	135	135
AltiConsole	AltiLink +	10025	
AltiControl	AltiLink+	10025	
AltiReach	AltiLink	10015	
AltiView/AltiAgent	AltiLink+	10025	
	VM Service	10028	
Supervisor	AltiLink+	10025	
	Internal/External CDR Logger	10027	
CDRSearch	AltiLink+	10025	
	Internal/External CDR Logger	10027 10029	
TAPI Client	TAPI Gateway	10026	
IP 710	AltiGen IP Phone Service	10032	
	GateKeeper		1718, 1719
VoIP H.323/H.225	VoIP H.323/H.225	1720	

Client	Server	TCP	UDP
VoIP Message Waiting	VoIP Message Waiting	49151	
VoIP H.245	VoIP H.245	From 49152 to N ^b	
VoIP RTP	VoIP RTP		From 49152 to N ^b
VoIP ATPS	VoIP ATPS	10032	
Web Client	AltiLink+ NetMeeting Chat plus VoIP ports described above	10025 1720	

a. It is recommended that this be run only in an **intranet**.

b. N=49152+ (62*number of boards)-1

Troubleshooting

The following table provides help for the most common problems an end user may encounter. For IP 710 phone questions or problems not listed here, contact AltiGen Technical Support.

Problem/Symptom	Solution
AltiWare is unreachable	<ul style="list-style-type: none"> • Check to make sure the AltiWare IP address in the IP phone is set up correctly. • Check the IP 710 phone's IP address, network mask and default gateway. • Check to make sure you can ping the IP 710 phone's address from AltiWare. • Check to make sure the IP Phone Services is started in AltiWare. • Check AltiWare IP address in AltiAdmin IP Phone Configuration menu.
Image update failed. If setting <code>Boot Download</code> to Yes, after the phone reboots and if the setting still says Yes, the boot failed.	<ul style="list-style-type: none"> • Check the IP 710 phone's IP address, network, default gateway settings. • Check the network connection. • Check the TFTP server IP address and make sure the TFTP server is running. • PING from the TFTP server to the IP 710. • Check to make sure app_710.bin and dsp.bin files exist in TFTP server directory.

Troubleshooting

IP phone registered then goes back to Basic mode	<ul style="list-style-type: none">• Check network connectivity by pinging from Altiserv to the IP phone.• Check if IP Phone Service is running.• Check if there is a duplicate IP address by unplugging the Ethernet cable on the IP phone, then pinging the IP 710 phone's IP address.• Check the extension's IP address in AltAdmin to find out if another user is trying to log in using the same extension number.• Use #27 then Enter to log in again and see if the problem persists.
No IP Address	<ul style="list-style-type: none">• Check if DHCP is enabled. If YES, check network connection. If NO, verify your DHCP server is correctly configured.• Check if IP 710 phone's IP address is configured.
One way connection	<ul style="list-style-type: none">• Make sure firewall setting has all the TCP/UDP ports required by AltWare opened.• If NAT is used, make sure NAT is enabled and NAT address is set up correctly.
Phone does not show anything on LCD display	<ul style="list-style-type: none">• Check the power source to be sure the IP 710 phone is receiving power.
Poor voice quality	<ul style="list-style-type: none">• Make sure a switch is used, rather than a hub, in the corporate LAN.• G.711 provides better voice quality.• If VoIP is set up over WAN, set priority queuing on the WAN router.• Make sure WAN QoS is okay by pinging a few hundred packets from remote site and observe packet loss and network latency.• Adjust jitter buffer to accommodate network latency.

Register failed	<ul style="list-style-type: none">• Check to make sure the extension number and extension password are set up properly and that the IP extension is enabled.• Check to make sure the IP Phone Service is started in AltWare.• If IP phone is associated with a physical phone (with the same extension number), use #27 to activate the IP phone to normal operating mode.
-----------------	--

LCD Messages

Normal Operating Mode Messages

In normal operating mode, the phone's LCD screen displays the time and the extension number on the first line

12:00 PM	x555
DND	MISSED xx 3VM

If an activity code has been set on the phone, that code is displayed in place of the extension number. Examples of activity codes are MEETING, AWAY, TRAVEL.

Other messages you may see:

DND or FWD - The extension has Do Not Disturb on or is set to forward all calls.

MISSED xx - Number of calls missed.

VM - Indicates the number of new voice messages.

Workgroup Status Display

When the administrator has configured a soft key to display workgroup status when pressed, the workgroup status display is in the following format:

WG 200	CIQ 05	LQT 05
LOGIN	>TH 02	SL 060

WG - workgroup number

CIQ - number of calls currently in the queue

LQT - longest queue time of current queued calls

LOGIN - LOGIN/LOGOUT indicates the agent login/logout state

TH - number of calls in queue whose queue time is greater than the service level threshold

SL - service level in percentage

Local Menu Configuration Messages

The following messages may be displayed in the LCD when accessing the IP 710 phone's menu:

Message	Explanation
conf timeout!	After 2 minutes inside the configuration menu, if no action is taken, the LCD will show this message and then quit the menu.
conf exception!	During configuration, an unknown exception occurred.
Saved!	The changed configuration was saved into memory.
Write Fail!	Error occurred when saving the changed options into flash ROM.
Wrong Ext Number!	The inputted extension number is invalid.
Wrong input!	User inputted an invalid value or string during configuration.
wrong password!	User is trying to configure an invalid password from the phone menu.

IP Phone Running Messages

The following messages may be displayed in the LCD when running the IP 710:

Message	Definition
AW UNREACHABLE!	Failed to connect to the AltiGen phone server. The user is trying to register the IP phone with an invalid IP phone's IP address or the AltiGen Phone Server's IP address is invalid. Or, the network connection is lost in offhook or connect state. Refer to "AltiWare is unreachable" section of "Troubleshooting" on page 49.
Basic-Idle!	IP phone is operating in Basic mode. Press #27 again to reactivate. Check IP Phone Service Verify extension is configured for dynamic.
DHCP FAIL!	Although DHCP was enabled, the IP 710 was not able to receive the IP address from the DHCP server.
DUPLICATE IP!	Another device configured with the same IP address as the IP phone is detected. The IP phone cannot function correctly until this is corrected.
INVALID IP! INPUT AGAIN...	The inputted IP address is invalid.
INVALID VAL!	During register of IP extension, an invalid response (return value) returned from phone server.
NO IP ADDR!	IP 710 cannot attach an IP address due to network failure.
No Network!	Phone has lost Ethernet connection.
REGISTER FAIL!	Cannot register to the AltiGen phone server.
REGISTER OKAY!	IP extension registered successfully.

REGISTERING!	User entered #27 to manually register the IP extension.
REMOVE OLD EXT.	When #27 is entered, the extension/password configuration in the IP phone is removed.
WRONG PASSWORD!	Registration failed because of invalid extension password.

IP Phone Boot Messages

The following messages may be displayed in the LCD when booting the IP 710:

Message	Definition
Boot Done	The phone successfully booted.
CHECK FW	Checking firmware.
CHECK MEMORY	Checking memory.
INIT NETWORK	Initializing network.
LOAD FAILED	Failure to load the image into memory.
LOADING FW...	Loading firmware.
LOADING NOW	Loading firmware.
NETWORK FAILED.	Network initialization failed.
TFTP FAIL!	Failure downloading TFTP.
UPDATE FAILED.	Firmware update failed.
UPDATE OK	Firmware update successful.
update APP(S1)	Appears when Boot Download is set to TRUE. The IP 710 will show this message when it is rebooted.

User Reference

Basic Phone Operation

* Indicates a normal operating mode phone feature, which is available only after registering the IP 710 with the phone server and logging in as an extension.

FUNCTION	KEY SEQUENCE
Activity	1) Press the Activity button. 2) Use the ▲/▼ buttons to select the appropriate activity, and press the Enter button. Callers in the system are notified of the activity status when a call is not answered.
Auto Answer	1) Press the Menu button, select PHONE SETTING, then select AUTO ANSWER. 2) Use the ▲/▼ buttons to enable/disable Auto Answer mode, and press Enter . 3) Select AUTO ANS RING from the menu. 4) Set the number of seconds to ring before auto answer (1-20), and press Enter . 5) Select AUTO ANS DEV from the menu, then select from speaker or headset as the Auto Answer device, and press Enter .
Call Log*	1) With the phone onhook, press the Call Log button. 2) Use the ▲/▼ buttons to scroll to the number you want. 3) Press the Enter button to dial the number. The Call Log stores up to 99 incoming numbers.

Conference*	<p><i>To initiate a conference during a call:</i></p> <ol style="list-style-type: none"> 1) Press the Conference button (this automatically selects a new line and places the other party on hold). 2) Enter the target telephone number. 3) When the call connects, press the Conference button again OR the ◀ button to cancel the conference and return to the original party. <p>The number of parties allowed in a conference call depends on the Altiserv system. In general, up to 6 parties are allowed.</p> <p><i>To conference an incoming call when no conference is in progress:</i></p> <ol style="list-style-type: none"> 1) Connect to a caller. 2) Get incoming call whose Caller ID or Caller Name is displayed on the LCD. Call waiting tone is played. 3) Press the Enter button to answer caller and place the original caller on hold. 4) Press the Enter button to select the original hold call. 5) Press the Conference button to create a conference and join both callers. <p><i>If a conference is already in progress, to conference an incoming call:</i></p> <ol style="list-style-type: none"> 1) Press the Enter button to answer the incoming call (all other conference members remain in conference). 2) Press the Enter button and select one of the members in conference (displays "ConfHold"), then press the Conference button to join the incoming caller to the conference. <p>The user who initiates the conference call can select another conference member's call and drop it from the conference.</p> <p><i>To drop a conference member:</i></p> <ol style="list-style-type: none"> 1) Use the ▲/▼ buttons to select the member to disconnect. 2) Press the ◀ button to disconnect this caller. <ul style="list-style-type: none"> • This feature is not available to other conference members, even when the conference initiator hangs up.
Configuration Menu	<ul style="list-style-type: none"> • Press the Menu button to display the phone menu. • Use the ▲/▼ buttons to scroll to the menu item you want. • Use the ▶ button or Enter button to select a menu item or setting. • Use the ◀ button to return to the previous menu.

Greeting*	Press the Greeting button to quickly access voice mail greetings.
Handset/ Headset/ Speaker	To switch between handset, headset and speaker, the user can go offhook, press the Speaker button, or press the Headset button.
Hold*	<p><i>During a call:</i></p> <p>1) Press the Hold button to put the current call on hold and make a new call.</p> <p><i>To retrieve a single call on hold:</i></p> <p>1) Press the Hold button.</p> <p><i>To retrieve multiple calls on hold:</i></p> <p>1) Use ▲/▼ to select a hold call to be retrieved. 2) Press the Enter button.</p> <p>OR</p> <p>1) Press the Hold button to retrieve the last hold call.</p>
Intercom*	<p><i>Incoming Intercom:</i></p> <p>Incoming voice path is heard through the speaker, indicated by the button's blinking indicator light.</p> <p><i>Outgoing Intercom:</i></p> <p>1) Press the Intercom button, then the extension number.</p>
Line Park*	<p><i>During a call:</i></p> <p>1) Press #51 and then enter the 2-digit Line Park line. OR, press the Line Park key (if the administrator has configured one). The Line Park key's light will be lit and turns off when the parked call is picked up, the caller hangs up, or the call is routed to voice mail.</p>
Mute	<p><i>While on a call with speaker, handset, or headset on:</i></p> <p>1) Press the Mute button. 2) To disengage mute, press the Mute button again.</p>
Program Soft Key	<p>1) Press the Menu button. 2) Select PHONE SETTING, then PROGRAM KEYS, then the desired program key. 3) Enter the appropriate digits for the speed dial number or feature code.</p>
Reboot	1) Press * * 3, then the Enter button

Redial	<p><i>Phone is onhook</i></p> <ol style="list-style-type: none"> 1) Press the Redial button. 2) Use ▲/▼ to scroll to the desired entry. (▲ scrolls to previous entry, ▼ scrolls to first entry.) 3) Press the Speaker button or raise handset. <ul style="list-style-type: none"> • Redial up to last 16 calls. • Redial up to 32 digits.
Release	<p><i>For a connected call:</i></p> <ol style="list-style-type: none"> 1) Press the Release button to hang up the call. <p>Also, press the Release button to exit the menu.</p>
Restore Default Settings	<ol style="list-style-type: none"> 1) Press the Menu button. 2) Press * * 2, then the Enter button.
Ring Tones	<ol style="list-style-type: none"> 1) Press the Menu button. 2) Select PHONE SETTING, and scroll to RING TONES. 3) Select a ring tone and press the Enter button.
Soft Key* <ul style="list-style-type: none"> • N/A • BLF • Feature Code • Speed Dial • Line Park • Call Record • Workgroup Status • Phone Setting 	<ol style="list-style-type: none"> 1) Press the appropriate soft key (keys 1-15) to initiate one of the following functions pre-assigned by the system administrator: Busy Lamp Field, AltIServ Feature Code, Speed Dial, Line Park, Call Record, Workgroup Status, Phone Setting. <p>To configure a soft key with Phone Setting enabled:</p> <ol style="list-style-type: none"> a. Press the Menu button, select PHONE SETTING, and press the Enter button. b. Scroll to PROGRAM KEYS and press Enter. c. Select the key to program, and press Enter. d. Enter the appropriate digits for the speed dial number or feature code, and press Enter. <p>The digits are automatically dialed when this function key is pressed.</p>
Speaker	<p><i>To use the speakerphone:</i></p> <ol style="list-style-type: none"> 1) Press the Speaker button. 2) To disconnect the call, press the Speaker button again.
Speed Dial*	<ol style="list-style-type: none"> 1) Press the Speed Dial button to see a list of phone numbers configured by the system administrator. 2) Use ▲/▼ to scroll to the desired entry. 3) Press the Enter button to dial the number.

<p>Transfer*</p>	<p><i>During a call:</i></p> <ol style="list-style-type: none"> 1) Press the Transfer button, which places the call on hold. 2) Dial the number you want to transfer the call to. 3) Hang up if the party answers the call, or press Transfer again to complete transferring. 4) If the party refuses the call, return to the original call by pressing the ◀ button or the Flash button.
<p>Voice Mail</p>	<ol style="list-style-type: none"> 1) Press the Voice Mail button. 2) Enter voice mail password. <ul style="list-style-type: none"> • The Message Waiting light blinks when a voice mail message is waiting. • The LCD displays the new voice mail count (which includes only unheard messages) when onhook.
<p>Volume</p>	<p>To adjust volume on handset/speakerphone/headset:</p> <ol style="list-style-type: none"> 1) Depending on which volume you want to adjust, take the phone offhook by lifting the handset, pressing the Speaker button, or pressing the Headset button. 2) Press the Volume button. The device name and volume level appear in the LCD. 3) Press the left side of the Volume button to decrease the volume; press the right side to increase the volume. <p>To adjust ringer volume:</p> <ol style="list-style-type: none"> 1) Leave the phone onhook. 2) Press the Volume button; a sample ring plays and the volume level appears in the LCD. 3) Press the left side of the Volume button to decrease the volume; press the right side to increase the volume.

**** Feature Codes**

- ** 2 Restore default settings (when user is in the Configuration Menu)
- ** 3 Reboot

AltiServ Feature Codes

- ## <pwd> Log in to voice mail at your own station
- ### <ext> <pwd> Log in to voice mail at another station

AltiGen Voice Mail System Quick Features

- #11 Greeting Menu
- #28 Password Menu

Making Calls

- #34 Dial By Name¹
- #35 Virtual Log In (Station Privilege Override)
- #69 Dial Last Caller

¹ Feature must be enabled by system administrator.

#77	Station Speed Dial
#88	System Speed Dial
#99	Last Number Redial
#93 <ext>	Intercom Call ²
Answering Calls	
#29 <ext>	Individual Call Pickup (a specific station)
#30	System Call Pickup (any station ringing)
Flash button #31	Personal Call Park
#31 <ext>	Personal Call Park Pickup
Flash button #41	System Call Park
#41 <loc. #>	System Call Park Pickup
#51 <line park line>	Line Park Pickup
#81	Hands Free Intercom Mode
#82	Hands Free Manual Answer Mode
Call Management	
#26	Station Log Out (Phone must be onhook)
#27	Station Log In (Phone must be onhook)
#32 <acct code>	Enter Account Code (before dialing)
Flash button #32 <acct code>	Enter Account Code (mid-call)
#33	Do Not Disturb
#36	Call Forwarding
#37	Remote Call Forwarding
Other Features	
#22	Feature Status Check
#25	Station Speed Dial Setup
#38	Outside Call Blocking (operator only)
#39	Operator Off-Line (operator only)
#44	Overhead Paging
#45	Overhead Paging by Trunk
#46	Group Paging (for IP 710 phone users)
#55	List Feature Tips
#73	Silent System Call Park
#90	Ready to receive workgroup calls
#91	Not ready to receive workgroup calls
Flash button #40	Transfer to AltiGen Voice Mail System
Flash button # 15 <AA#>	Transfer to Auto Attendant
Flash button # # <ext>	Transfer to a User's Voice Mail
Flash button <ext> Flash button	Consultation

Dialing an IP Number Directly from the IP 710

To dial an IP number directly from the IP 710 phone set, enter the IP address, using the * key to enter periods and followed by the # key.

Note: This works only when the IP 710 is operating in Basic mode.

If the IP 710 is configured for a public IP address, you can call other public IP address devices. If the IP 710 is configured for a private IP address, you can call other private IP address devices that you can “see” or that are on your subnet.

² Feature available only on systems with Triton Analog Extension board.

Index

A

- activating IP phone extension 16
- Activity button 31, 34
- AltiAdmin/ACM Admin configuration requirements 7
- AltiGen Communications
 - contact information ii
- AltiGen IP Phone Service 8
- AltiWare Server, setting IP address 24
- assigning
 - a local IP address 27
 - a TFTP server 27
 - NAT 29
- audio standards 47
- auto answer 34
 - device 34
 - ring 34

B

- Basic mode 8
- BLF, configuring 14, 35
- Boot Download 24
- Busy Lamp Field, configuring 14, 35

C

- call control protocols 47
- Call Log button 3, 35
- Call Record button, using 36
- call record, configuring 15, 36
- Conference button, using 36
- configuration requirements
 - AltiAdmin/ACM Admin 7
- configuring
 - AltiWare vs IP phone 15
 - from IP phone menu 23
 - in AltiAdmin/ACM Admin 10
 - IP settings 26

NAT 29

D

- debugging 12
- default settings, restoring 20
- DHCP, enabling/disabling 25, 26
- dial pad 3
- dialing IP number 61
- dimensions, IP 710 phone 48
- display workgroup status 36
- distinctive ring options 30

E

- emergency gateway, setting 25
- emergency number, setting 25
- Enter button 2
- errors, rebooting 29
- errors, startup 19
- extension
 - activating IP phone 16
 - number, setting 23
 - password, setting 23

F

- feature code, configuring 14
- features, list of 33
- firewall
 - network ports 48
 - port configuration 8
- firmware, updating 27
- firmware, upgrading 24
- Flash button 3

G

- GateKeeper Discovery, enabling/disabling 25
- gatekeeper, enabling/disabling 25
- gateway, setting IP address 25
- Greeting button 37

H

- H.323 NAT router 17
- handset port 5

Index

hardware components 5
headset
 plug receptacle 5
 port 5
 port support 48
Headset button, using 37
Hold button, using 37

I

installing IP 710
 locally 9
 remotely 17
Intercom button 37
IP 710 phone
 functions, list of 33
 hardware components 5
 illustration 1, 4, 5
 overview 1
 registering 26
 specifications 47
 time display 12
IP address
 assigning a local 27
 inputting in LCD 26
IP number, dialing 61
IP settings, configuring 26

J

jitter buffer 11

K

keys, feature 47

L

LAN ports 47
LCD messages, explained 52, 54, 55
LCD screen 1, 47
LED, in buttons 47
line park, configuring 14, 38
local address, setting 25
logon, to extension in use 20

M

memory, IP 710 phone 47
Menu button 2
Message Waiting light 2
Mute button 38

N

NAT
 address, setting 25
 assigning 29
 configuring 29
 enabling/disabling 25
 H.323 router 17
navigation buttons 2
network
 mask, setting 25
 protocols 47
 requirements 7
 settings, configuring from
 phone 25
normal operating mode 8

O

operating mode
 Basic 8
 normal 8

P

password, setting extension 23
periods, inputting in LCD 26
phone operation 56
phone setting soft key 15
phone startup, verifying 19
plug and play 8
 setup after starting phone 20
PoE module 5
 installing 21
 removing 22
port
 handset 5
 headset 5
power over Ethernet
 module 5

using 21
power, IP 710 phone 48

R

rebooting 21
rebooting errors 29
Redial button 38
registering IP phone 26
Release button 3, 38
remote installation 17
restoring default settings 20
ring tones, setting 30, 39

S

service, getting vi
settings, restoring default 20
setup, IP 710 9
soft keys
 configuring 14
Speaker button 39
specifications 47
speed dial
 administrator configuration 14
 user configuration 15
SpeedDial button 3, 39
startup
 errors 19
 verifying phone 19
system requirements 7
system settings, configuring from
 phone 24

T

TFTP server
 assigning 12, 27
 setting IP address 24
time display 12
time offset, setting 24
Transfer button 39
troubleshooting 49

U

updating phone firmware 27

user reference 56

V

verifying phone startup process 19
version information 25
Voice Mail button 39

W

warranty v
 how to get service vi
workgroup queue status, configuring
 display 15, 36
workgroup queue status,
 displaying 31